

**INSTALLATION, OPERATION and
MAINTENANCE MANUAL**

**MODEL SHZF1 rated 15, 30, 40, 60, 70, 90 and 120A
MODELS SHZF2 and SHZF3 rated 15, 25, 30, 60, 90, 120, 180 and 225A
SINGLE PHASE and THREE PHASE – 2 or 3 LEG CONTROL
SCR POWER CONTROLS**

UL/cUL FILE NUMBER – E151547

CE – See last page of manual for CE Declaration of Conformity

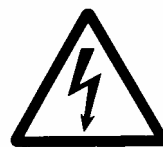

**AMETEK HDR POWER SYSTEMS
3563 INTERCHANGE ROAD
COLUMBUS, OH 43204**

**TEL: 614-308-5500
TOLL FREE: 1-888-797-2685
FAX: 614-308-5506**



SCR Power Controls/Systems & Power Supplies

Dear Client:

On behalf of all of AMETEK HDR's employees, I want to take this opportunity to "thank you" for purchasing an AMETEK HDR Power Systems' SCR Power Control.

We believe AMETEK HDR represents the best overall solution to your SCR Power Control needs in the industry today. We do this by providing a quality manufactured, reliable unit with fast, on-time delivery and a competitive price.

All of our employees are dedicated to your success. If you have any questions, comments or concerns, please call me toll free at 1-888-PWR-CNTL (797-2685).

Sincerely,

AMETEK HDR POWER SYSTEMS

A handwritten signature in cursive script that reads "George A. Sites".

George A. Sites
Vice President

GAS/be

REVISION PAGE

<u>Page</u>	<u>Change</u>	<u>Revision</u>	<u>Date</u>
Various	1	Added DIP Switch information	8/00

NOTE: ALL SPECIFICATIONS SUBJECT TO CHANGE WITHOUT PRIOR NOTICE.

COPYRIGHT 2003

AMETEK HDR POWER SYSTEMS

TABLE OF CONTENTS

<u>Para.</u>	<u>Title</u>	<u>Page</u>
Section 1 - DESCRIPTION		
1-1	Models Covered.....	1
1-2	General Description.....	1
1-3	Applications.....	1
1-4	Specifications.....	1
1-5	Options.....	2
1-6	Operation.....	3
1-7	Diagnostic Indicators.....	3
Section 2 - INSTALLATION		
2-1	Mounting.....	4
2-2	Line/Load Power Wiring.....	4
2-3	Fan and Thermostat Wiring.....	13
2-4	Input Line Voltage Changes.....	14
2-5	Safety Issues	14
Section 3 - COMMAND SIGNAL CALIBRATION AND WIRING		
3-1	Zero and Span Adjustments.....	16
3-2	Command Indicator.....	16
3-3	Isolated and Non-Isolated Inputs.....	16
3-4	Remote Manual Control.....	17
3-5	Process Command Signal.....	18
3-6	Auto/Manual Control.....	18
3-7	ON/OFF Control.....	19
3-8	Shutdown (Disable).....	20
Section 4 - MAINTENANCE		
4-1	Environmental Concerns.....	21
4-2	Line/Load Power Connections.....	21
4-3	Static Precautions when Servicing.....	21
4-4	Troubleshooting Typical Symptoms.....	21

Section 5 - SERVICE AND PARTS

5-1 Customer Service 23
5-2 Spare Parts..... 23
5-3 Warranty..... 23

TABLES and ILLUSTRATIONS

TABLES

<u>Table</u>	<u>Title</u>	<u>Page</u>
1	Specifications.....	2
2	Lug Size/Torque Information	4
3	Troubleshooting Zero Fired SCR Power Controllers	22

ILLUSTRATIONS

<u>Figure</u>	<u>Title</u>	<u>Page</u>
1	Line/Load Power Wiring – SHZF1.....	5
2	Line/Load Power Wiring – SHZF2.....	5
3	Line/Load Power Wiring – SHZF3.....	6
4	Outline and Mounting – SHZF1 15, 30, 40 and 60A.....	7
5	Outline and Mounting – SHZF1 70, 90, 120A.....	8
6	Outline and Mounting – SHZF2 15, 25 and 30A	9
7	Outline and Mounting – SHZF2 60, 90, 120, 180 and 180A.....	10
8	Outline and Mounting – SHZF3 15, 25 and 30A	11
9	Outline and Mounting – SHZF3 60, 90, 120, 180 and 225A.....	12
10	Fan & Thermostat Terminals.....	13
11	Remote Manual Control.....	17
12	Auto/Manual Control.....	18
13	ON/OFF Control.....	19
14	Firing Circuit Terminals & DIP Switches.....	20

Section 1 - DESCRIPTION

1-1 MODELS COVERED

This manual covers the SHZF1 rated 15, 30, 40,60, 70, 90 and 120A and the SHZF2 and SHZF3 models rated 15, 25, 30, 60, 90, 120, 180 and 225 amperes and options.

1-2 GENERAL DESCRIPTION

The SHZF1 is a single-phase, zero-fired (ZF) SCR Power Control. The SHZF2 is three-phase 2-leg/4 SCR control and the SHZF3 is a three-phase, 3-leg/6 SCR Power Controller. Each of these will operate on voltages up to 575 Vac and accept most all standard process command signals. Zero and Span multi-turn potentiometers are provided to ease command signal calibration. AMETEK HDR's zero-fired SCR Power Controls utilize a variable-time-base that helps maintain constant power to the load. This variable-time-base also helps minimize temperature overshoot, temperature fluctuations and helps extend the load element's life due to reduced thermal shock. The power SCR assemblies consist of two SCRs connected back to back with a semiconductor fuse, RC Snubber and MOV protection. The SHZF1 has one power assembly while the SHZF2 has two and the SHZF3 has 3. The firing circuit is based on common integrated circuits that provide very reliable operation. Terminals are provided to ease installation. Diagnostic indicators are included.

1-3 APPLICATIONS

Zero-Fired SCR Power Controls provide control of single or three-phase power by the switching action of two SCRs connected back to back in each controlled phase. By switching at the zero crossing point, RFI (Radio Frequency Interference) is virtually eliminated. Zero-Fired controllers are versatile enough to be used in place of mechanical contactors and mercury relays on dryers, kilns, ovens, environmental chambers, extruders, molding equipment, and most other applications where resistive heating elements are used.

Normal Zero-Fired SCR Power Controllers should never be used on inductive loads, if this is a requirement contact AMETEK HDR Power Systems about their ZFT3 3-Phase, Zero-Fired SCR Power Controller designed for firing into transformer primaries.

1-4 SPECIFICATIONS

Refer to Table 1 for specifications on AMETEK HDR's Zero-Fired SCR Power Controls.

Table 1
Specifications for HDR's SH Series of Zero-Fired SCR Power Controls

CONTROL METHOD	- Zero firing of back to back SCRs per controlled phase.
VOLTAGE RATINGS	-120, 240, 400, 480, 575VAC, 50/60 Hz.
CURRENT RATINGS	- 15 through 225A
COMMAND SIGNAL	- 4 to 20ma, 0 to 5VDC/0 to 10VDC, manual control.
ISOLATION	- 2500Vrms from line/load to command signal, 500Vrms to ground.
LINEARITY	- Output Power is linear to command signal (fixed load).
VOLTAGE REG.	- $\pm 1\%$ for $\pm 10\%$ line voltage change.
SCR PROTECTION	- Current surge, semi-conductor fuses; transient voltage, metal oxide varistor (MOV) and R-C snubber
ADJUSTMENTS	- Zero and Span, multi-turn
DIAG. INDICATORS	- Control power, command signal, blown fuse.
AMBIENT TEMP.	- Operating 0 - 50 °C, Storage -10 - 70 °C
AGENCY APPROVALS	- UL, cUL Listed & CE Compliant

1-5 OPTIONS

Available SHZF1 options:

Over-temperature thermostats are available as normally open (NO) or normally closed (NC). Thermostats are included on 90 through 120 ampere units as standard equipment, specify NO or NC. Either normally open or normally closed thermostats are available as an option on units rated 60 amperes, include NO or NC in your part number when specifying.

The following options are available for the SHZF2 and SHZF3 models:

Over-temperature thermostats are available as normally open (NO) or normally closed (NC). Thermostats are standard equipment on units rated 90 through 225 amperes but needs to be specified as NO or NC. If not specified, NO will be supplied. Both are available as an option on 15 through 60 ampere rated units but must be specified.

An Unbalanced Load alarm (UB) is available as an option. Add UB to the model number when ordering an SHZF2 or SHZF3.

A Shorted SCR Failure alarm (SF) is available as an option. Add SF to the model number when ordering.

1-6 OPERATION

AMETEK HDR's Zero-Fired SCR Power Controls control power by the switching action of two SCRs connected in a back to back configuration in each controlled phase. The gating of these SCRs is synchronized with the line frequency (either 50 or 60 HZ) by the zero crossing detector built into the firing circuit.

Zero-Fired SCR Power Controls turn the two SCRs in each phase on alternately as the incoming power passes through the 0° point of the sine-wave. The length of time these stay turned on is determined by the firing circuit and is based upon the input command signal.

The variable-time-base (VTB) firing circuit ensures that the off time (number of off cycles) is minimized for any command signal level. This helps ensure load power as constant as possible while minimizing temperature overshoot, temperature fluctuations and helps extend heater element life by avoiding thermal shock and mechanical stress.

1-7 DIAGNOSTIC INDICATORS

Light Emitting Diodes diagnostic indicators (LEDs) are provided for aid in start-up or maintenance. A Control Power On indicator (Red) lights when the power controller has power applied. The Command Signal indicator (Green) varies in brilliance with command signal's input level. A Blown Fuse indicator (Yellow) is provided for each semiconductor fuse and lights when the corresponding fuse blows.

Section 2 - INSTALLATION

2-1 MOUNTING

Prior to mounting, verify the voltage and current rating of the SCR Power Control, the information is provided on the unit's nameplate. Determine the mounting dimensions from the outline drawings Figures 4 through 9. Mount the Power Controller so that air flow is upward through the heat sink fins. Ensure that air flow is unrestricted. Keep in mind that higher current units require larger input/output cable. Allow plenty of room.

2-2 LINE/LOAD POWER WIRING

Connect the line/load using appropriately sized and insulated wire/cable per NEC based on the voltage and current rating of the Power Control. Cable lugs are provided on all SH Series units. Refer to Table 2 for lug sizes and torque information.

WARNING	
Branch circuit overcurrent protection is required to be provided in accordance with the national and/or local code of the inspecting authority or equivalent.	

Model	Size Wire/Cable	Torque
15-40A	(1) 2 to 14 AWG	25 in. Lbs.
60A	(1) 8 to 0 AWG	45 in. Lbs.
90A	(1) 8 to 0 AWG	45 in. Lbs.
120A	(1) 8 to 0 AWG	45 in. Lbs.
180A	(1) 6 to 250 MCM	250 in. Lbs.
225A	(1) 6 to 250 MCM	250 in. Lbs.

NOTE: U.L. requires 75°C rated wire (minimum) for all power connections.

Figure 1 - LINE/LOAD POWER WIRING SHZF1 MODELS

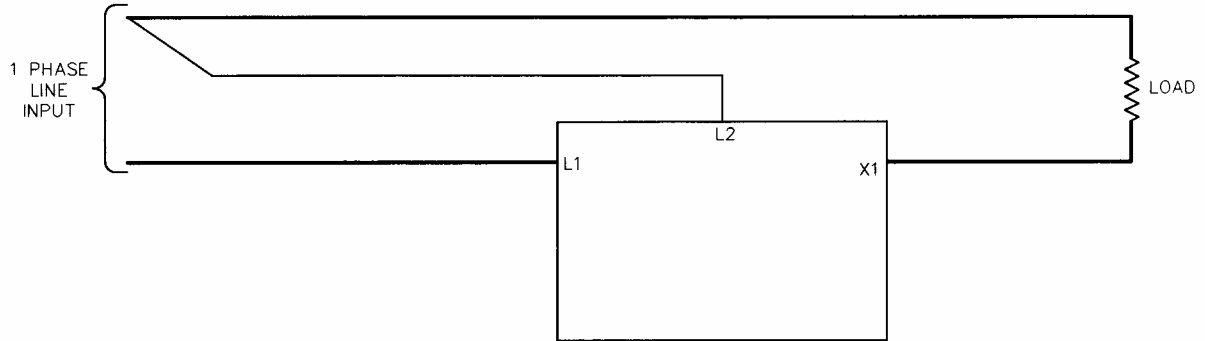

Figure 2 - LINE/LOAD POWER WIRING SHZF2 MODELS

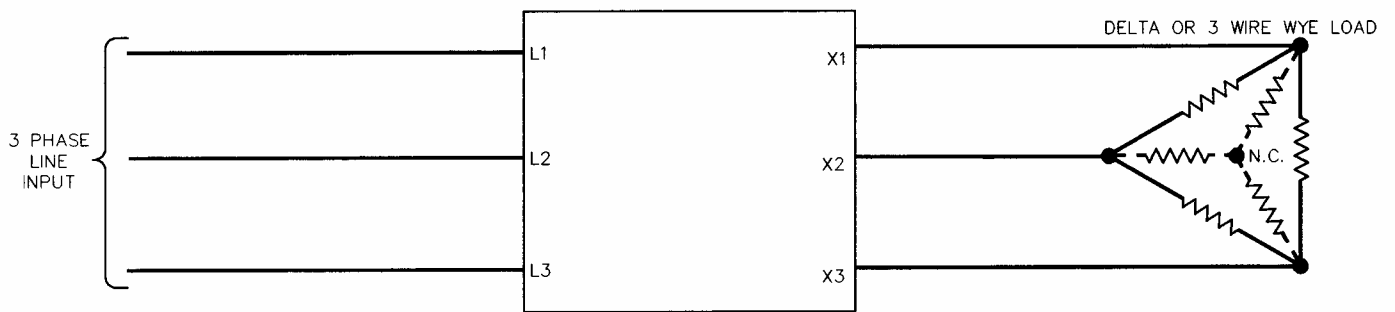

Figure 3 – LINE/LOAD POWER WIRING SHZF3 MODELS

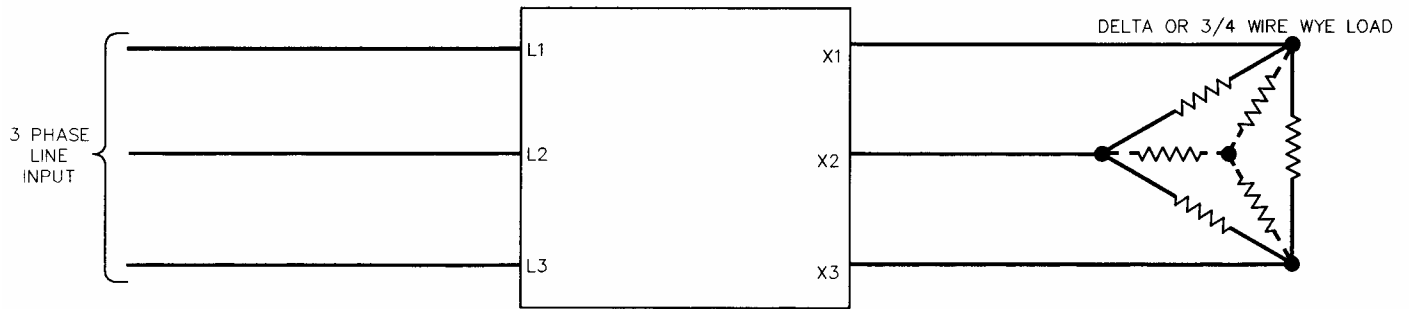

Figure 4 - OUTLINE AND MOUNTING SHZF1 15, 30, 40 and 60A

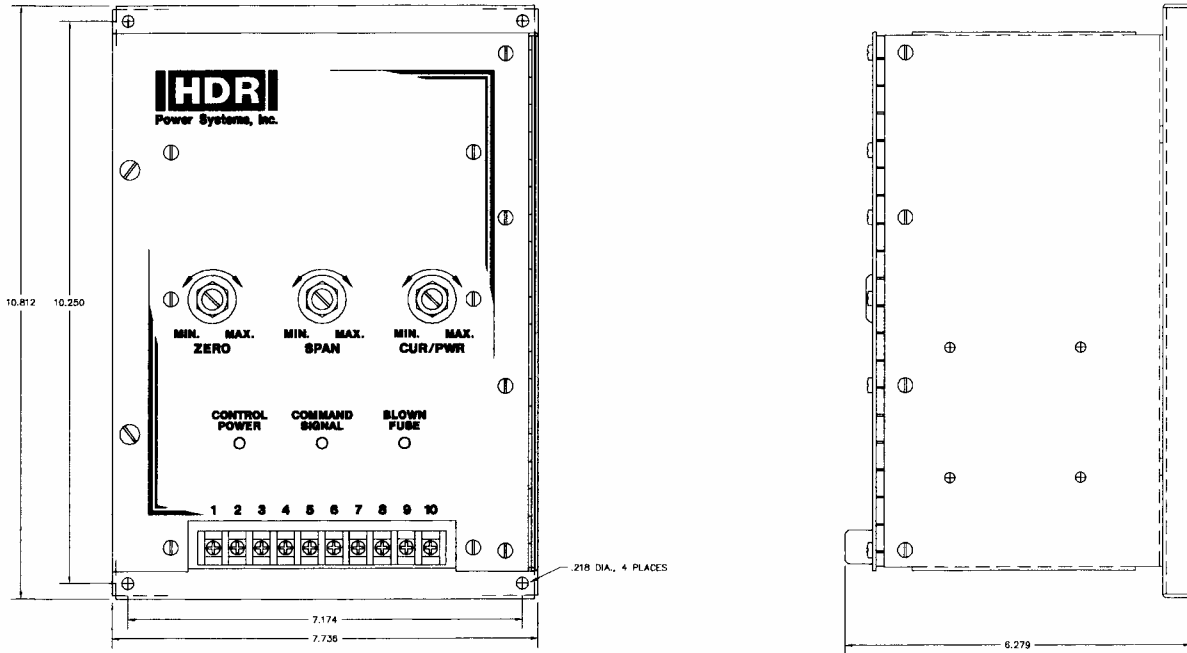

Figure 5 – OUTLINE AND MOUNTING SHZF1 70, 90 and 120 A

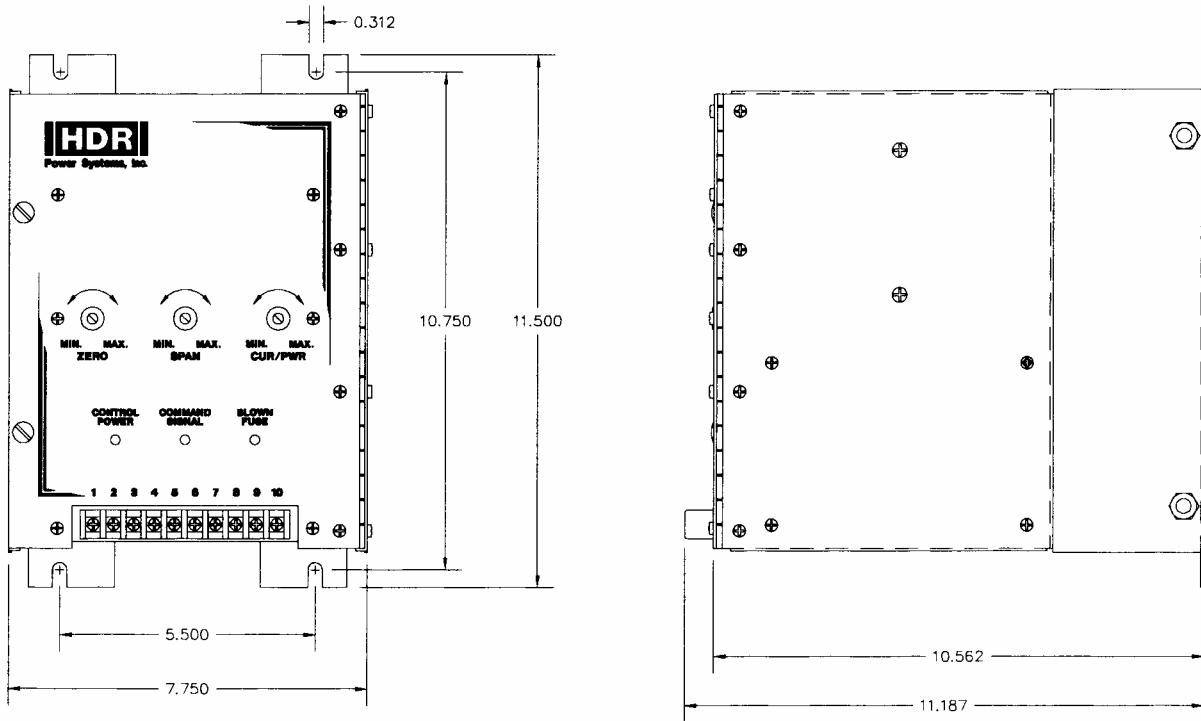

Figure 6 – OUTLINE AND MOUNTING SHZF2 15, 25 and 30 A

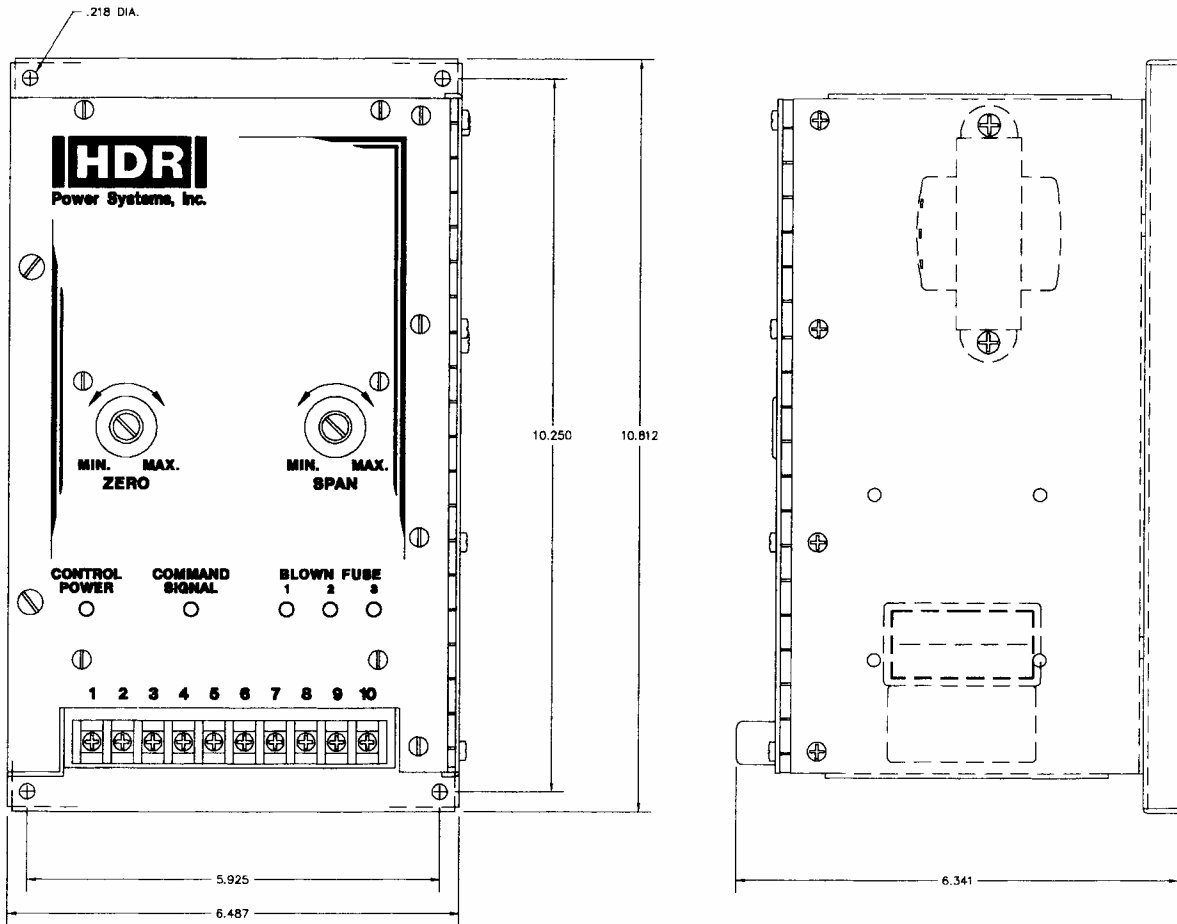

Figure 7 – OUTLINE AND MOUNTING SHZF2 60, 90, 120, 180 and 225 A

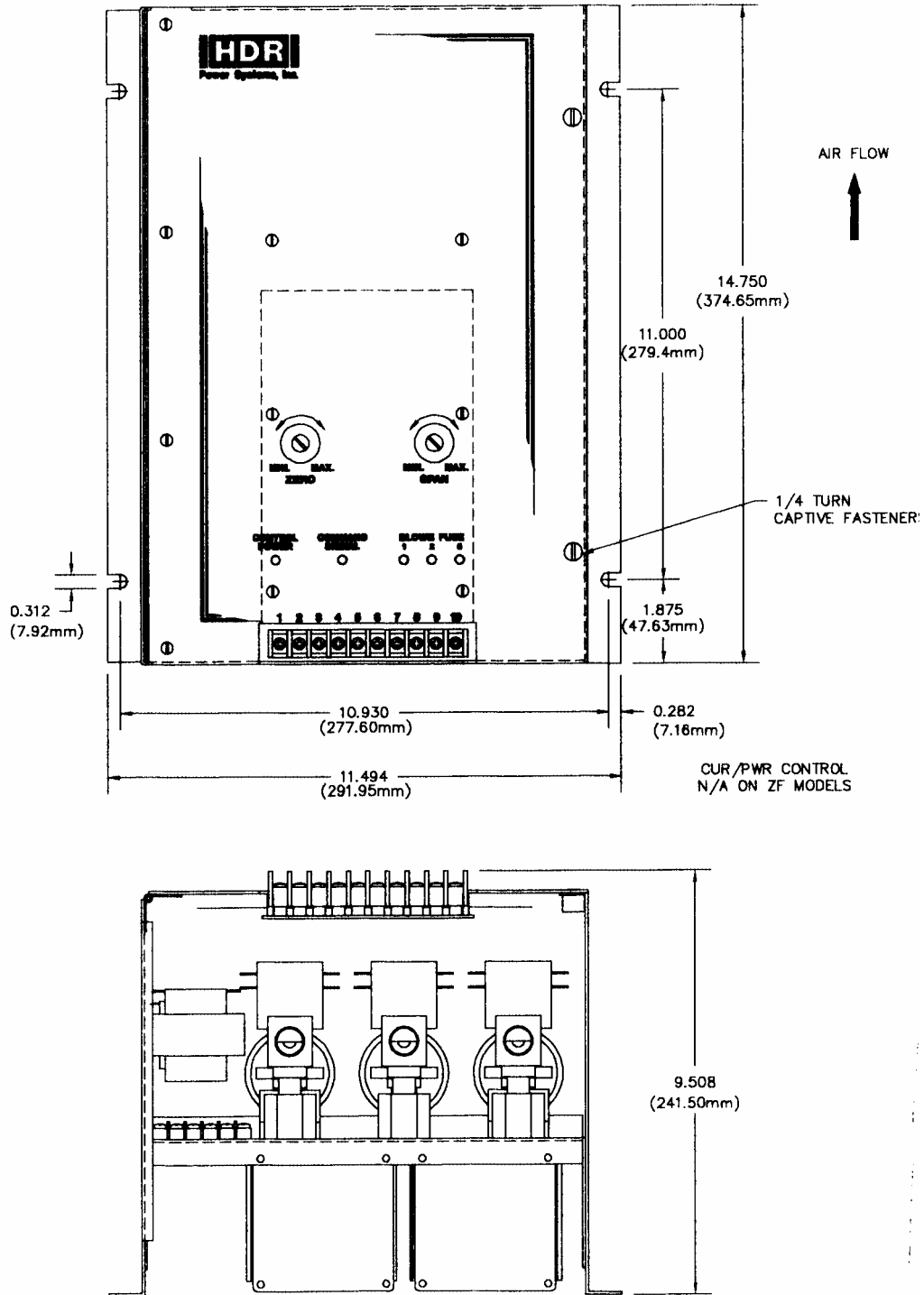

Figure 8 – OUTLINE AND MOUNTING SHZF3 15, 25 and 30 A

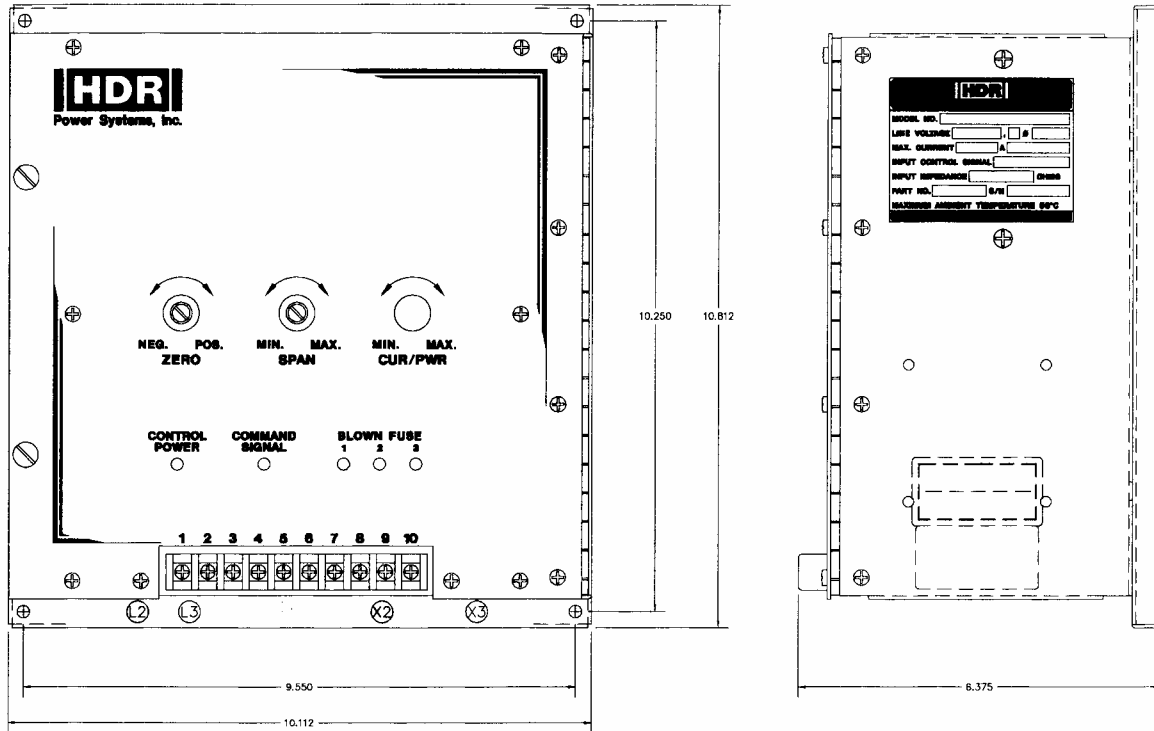
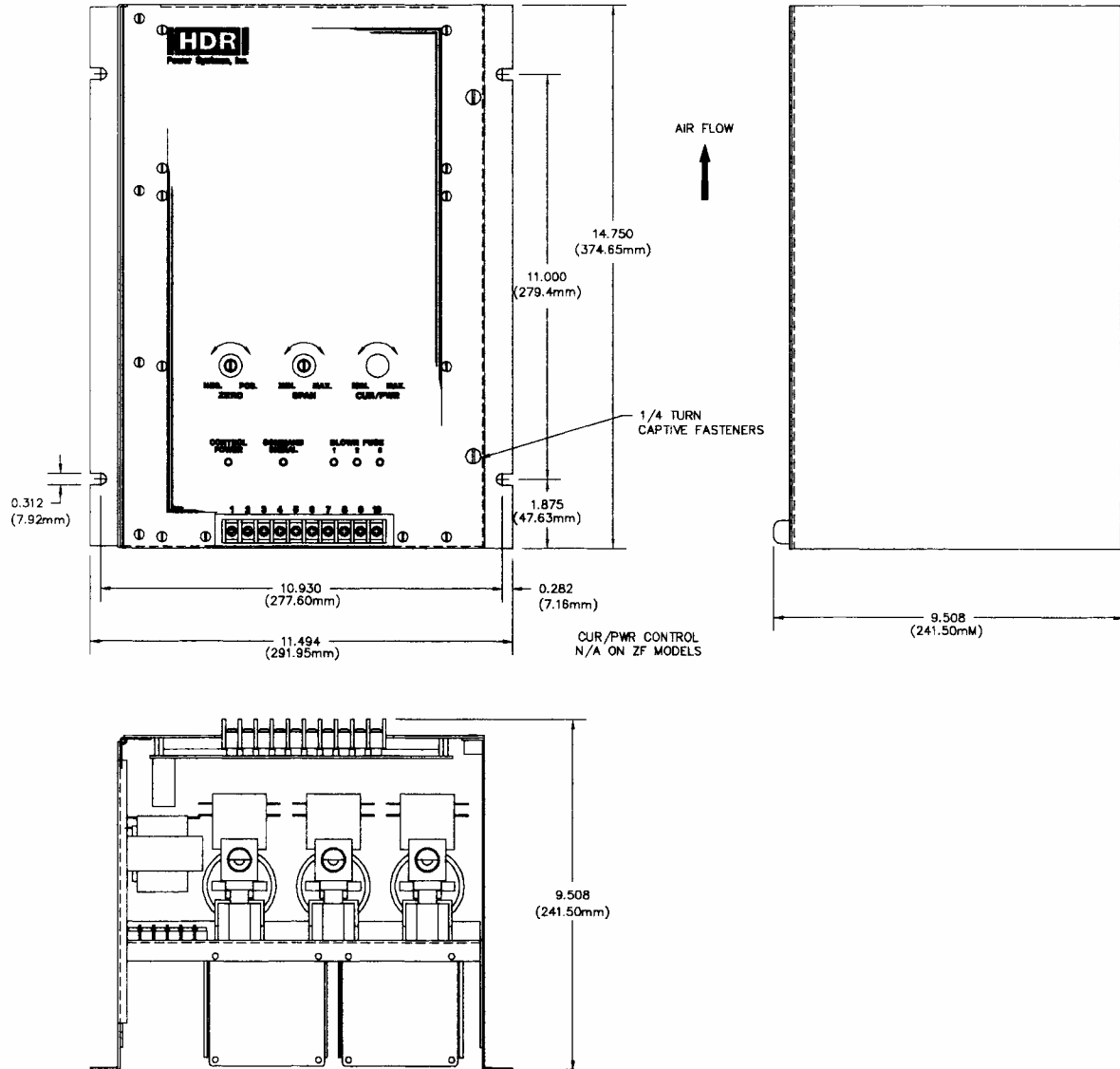
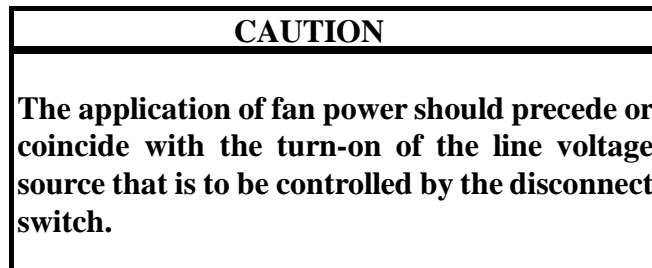

Figure 9 – OUTLINE AND MOUNTING SHZF3 60, 90, 120, 180 and 225 A



FAN AND THERMOSTAT WIRING

Fans and thermostats are supplied on all units above 90A. The user is responsible for supplying 120VAC (unless otherwise specified) for the fan. Fan power requirements are 30 VA for units rated 90 through 225A. Fan power should be connected to terminals 21 and 22.



Normally Open (NO) thermostats are standard on all units above 90A, Normally Closed (NC) thermostats may be specified. Normally Open or Normally Closed may be specified on the 60A model as an option. Thermostats are on terminals 23 & 24.

Figure 10 – FAN and THERMOSTAT TERMINALS

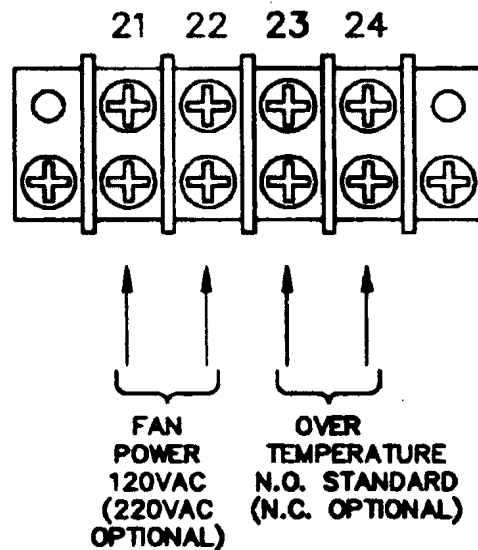

2-4 INPUT LINE VOLTAGE CHANGES

All units are shipped wired for the line voltage specified on the order. If some other voltage is required, it is normally a simple matter to change it. Open the door on the Power Control and locate transformer T1. Unsolder and move the white/black wire to the appropriate voltage tap. On newer units (starting September 2000) DIP switches have been added for selecting either 50 or 60 Hz operation.

WARNING
Hazardous voltages exist at the power controller heat sinks and at the load at all times when the input voltage is connected. This condition exists even when the controller is set to deliver zero output.

2-4 SAFETY ISSUES

The rated operational voltage of each power controller is shown on its nameplate, ie. 120V, 240V, 400V, 480V, or 575V. The power controller is designed to operate between +10% and -15% of this rated operational voltage in an Over Voltage Category III environment.

WARNING
Power control units are not suitable to provide isolation due to the use of semiconductors and other components that allow a small current to flow from line to load even when the unit is in the non-conducting mode.

The voltage drop across the switching semiconductor while in the conducting mode is approximately 1.5 volts and is somewhat a function of current. To calculate the power control's power loss, multiply the load current times 1.5 time the number of controlled phases.

The minimum operational current is approximately 1 A and the maximum off state current is approximately 15 ma.

The power controllers described in this instruction manual are designed to operate in a pollution degree 2 environment.



HAZARDS EXIST



DANGEROUS VOLTAGES EXIST

Section 3 – COMMAND SIGNAL CALIBRATION AND WIRING

3-1 ZERO AND SPAN ADJUSTMENTS

All SHZF series SCR Power Controllers have both Zero and Span potentiometers used for matching the SCR Power Control and the Command Signal. The Zero control is for the low end input (min. output) adjustments while the Span Control is used for the high end input (max. output).

The Zero control has both negative and positive voltages available making it usable as a manual or zero control. By turning the control clockwise, the output will increase proportionally to the adjustment. Turning it counter-clockwise will decrease or zero the output.

The Span control is used to adjust the maximum desired output. It will adjust for either a remote manual control or a command signal input. Clockwise adjustment increases the output while counter-clockwise adjustment decreases the output.

3-2 COMMAND INDICATOR

The Command Indicator is a green Light Emitting Diode (LED) located on the front cover of the unit. The brilliance of this LED will change with the Command Signal. The brilliance increases with an increased Command Signal and decreases with a decreased Command Signal. The LED is usable with 4-20ma Command Signals only and will be bypassed for other signals.

3-3 ISOLATED AND NON-ISOLATED INPUTS

The Firing Circuit has the capability of having either an optically isolated or non-isolated Command Signal input. The Power Controller will always be shipped with an isolated input unless specified otherwise (known exception is a Manual Control input.) The standard input impedance is 500 ohms for isolated and 1500 ohms for non-isolated.

An isolated input can be changed to a non-isolated input by simply unsoldering jumpers J1 and J2 on the firing circuit and moving them to the non-isolated position on the firing circuit. On newer units (starting September 2000) DIP Switch 1 replaces J1 & J2.

The isolated input works best with an offset Command Signal such as 4-20ma; however, it will work with both offset and zero based Command Signals. Zero based Command Signals may have a small amount of non-linearity (input to output) at the low end. This normally is not a problem on closed loop systems.

3-4 REMOTE MANUAL CONTROL

Some applications only require a manual control input and not a closed loop input from a process controller. The power controller is designed to accept a remote manual control input (refer to Figure 11 for connections.)

Adjustments are simple and quick, but first verify that the firing circuit is set up for non-isolated input and that R6 on the SHZF1, R7 on the SHZF2 or R5 on the SHZF3 has been removed. On newer units (starting September 2000) DIP Switch 2 has been added to make this conversion easier. Make sure it is in the 1.5K position. Next start with the Remote Manual Control in the zero (counter-clockwise) position, apply power to the Power Control. Adjust the Zero Control so the Power Control's output just starts to come on, then adjust it counter-clockwise so the unit's output is at zero. Now adjust the Remote Manual Control to the full output (clockwise) position, and adjust the Span Control until the maximum desired output is reached. This procedure may have to be repeated due to some interaction between the Zero and Span controls.

Figure 11 – REMOTE MANUAL CONTROL

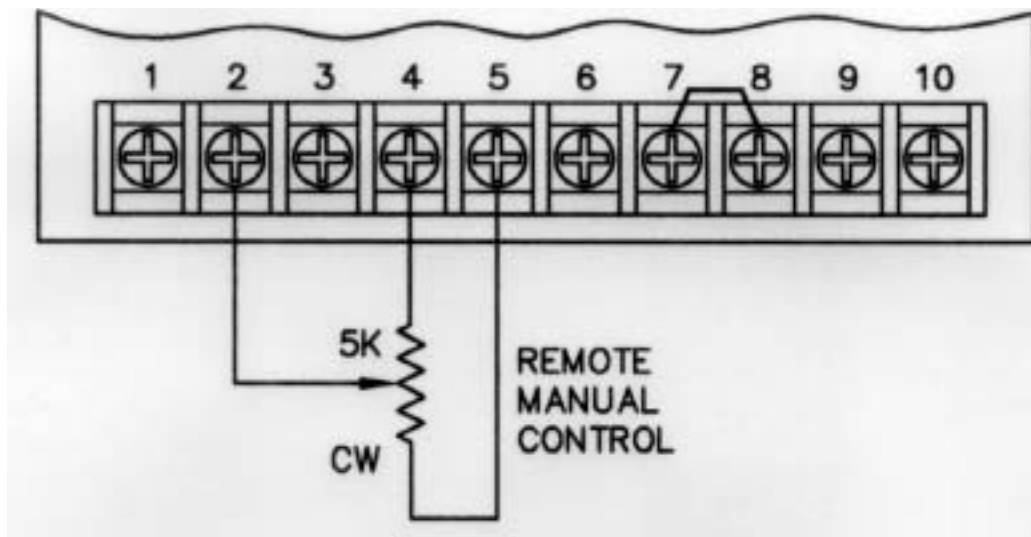

NOTE: Use voltmeter to monitor the output voltage, flickering is common at any setpoint other than zero or full output. Some load must be present when making adjustments or taking voltage measurements.

3-5 PROCESS COMMAND SIGNAL

Process command signals can be either offset or zero based as discussed earlier. Simply connect the command signal to terminals 1 (-) and 2 (+) on the firing circuit and adjust the Zero and Span controls. Adjustments are easy. Simply have the process controller's output set at minimum and adjust the Zero control so the unit's output is at zero. Next have the process controller's output set at maximum and adjust the Span control for the maximum desired output. As with the Remote Manual Control, some interaction between controls does exist so repeating this procedure may be necessary.

3-6 AUTO/MANUAL CONTROL

On closed loop processes it may be desirable to be able to operate the power controller manually. The AMETEK HDR power controller has this capability designed into it. Connect the Command Signal, a Remote Manual control and an Auto/Manual switch as shown in Figure 12. Make adjustments as stated for the Process Command Signal with the Auto/Manual switch in the Auto position. By switching to the Manual position, the Remote Manual control operates.

Figure 12 – AUTO/MANUAL CONTROL

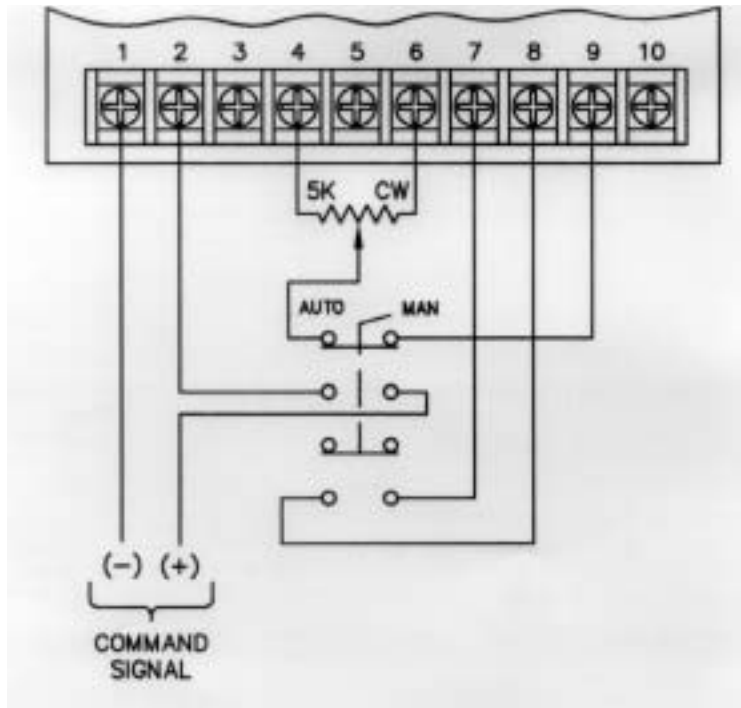

NOTE: Some non-linearity will occur with the Manual Control.

3-7 ON/OFF CONTROL

Some applications require that a simple ON/OFF type control be used. The power controller can be used in these simple applications. It can be connected for turn on by a contact closure.

For on/off control, wire the contact according to figure 13. Once the wiring is complete, turn on the input power. Set the input contact to open and adjust the Zero control clockwise until the unit comes on, then adjust counter-clockwise until the unit just shuts off. Now set the input contact to the closed position and adjust the Span control clockwise until the unit's output is at the desired maximum output level. Repeating of this procedure may be necessary due to some interaction between the Zero and Span controls.

Figure 13 - ON/OFF CONTROL

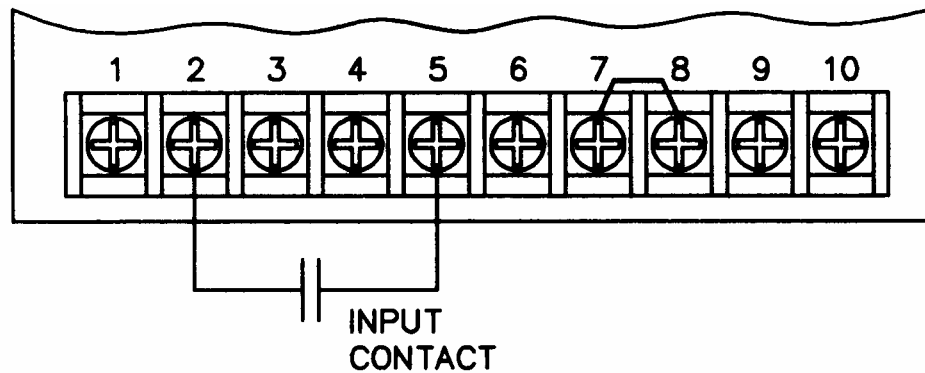

3-8 SHUTDOWN (Disable)

When it is necessary to shutdown or disable the output, it is a simple matter. Connect a dry contact closure between terminals 3 and 4 of the firing circuit. When it is closed, the power control will be shut off.

Figure 14 – FIRING CIRCUIT TERMINALS & DIP SWITCHES

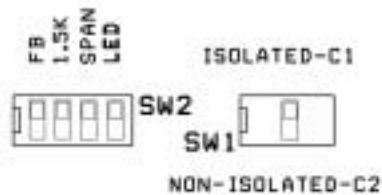
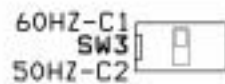
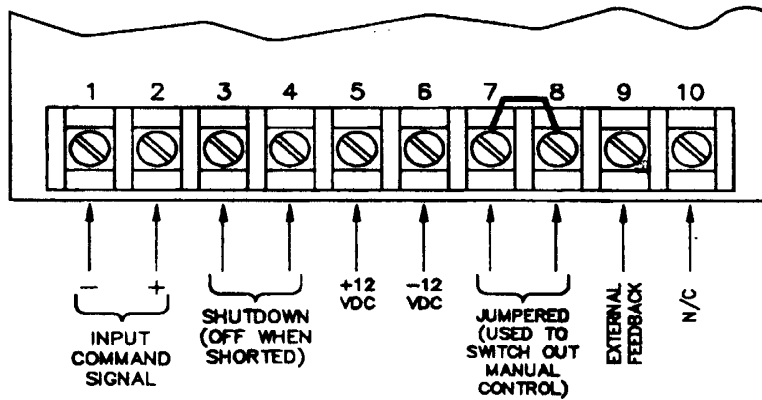

Section 4 - MAINTENANCE

4-1 ENVIRONMENTAL CONCERNS

Always verify that the SCR Power Controller is mounted in a clean, dust free environment. Clean the heat sink(s) and printed circuit board periodically so no dust and/or dirt accumulates on the unit. Dust and/or dirt on the heat sink fins can prevent proper airflow causing overheating of the semiconductors. Conductive dust and/or dirt can cause shorts or arcing, which can cause damage to the unit.

Always size your enclosure so that a 50 °C maximum internal ambient temperature is never exceeded.

WARNING

DISCONNECT ALL SOURCES OF POWER TO THE POWER CONTROLLER PRIOR TO CLEANING. THE UNIT IS NOT SUITABLE FOR HOSE DOWN CLEANING. USE VACUUM, BRUSH OR LOW PRESSURE AIR.

4-2 LINE/LOAD POWER CONNECTIONS

Periodically turn the power off to the SCR Power Controller and check for corrosion and tightness of the power connections. If any corrosion is evident, clean the cable and connector and reconnect making sure to tighten according to our torque specifications in Table 2.

4-3 STATIC PRECAUTIONS WHEN SERVICING

When servicing the Firing Circuit Printed Circuit Board (PCB), damage can occur due to static electricity. Always use a wrist strap grounded through a 1 megohm resistor. Transport the PCB in a static shielding bag. Caution in handling the PCB can help prevent any further damage to the PCB.

If you are not familiar with static precautions, consult the factory for additional details.

4-4 TROUBLESHOOTING TYPICAL SYMPTOMS

Any one of the following symptoms usually indicate a problem with the SCR Power Controller.

1. No output regardless of the input.
2. Full output regardless of the input.
3. Output is not variable from zero to full.

Refer to Table 3 for help in troubleshooting.

Table 3 - TROUBLESHOOTING

<u>Cause</u>	<u>Solution</u>
1. Open Fuse	Disconnect power and check the fuse. Replace if faulty. If not, contact the factory.
2. Shorted SCR	Disconnect power and check the SCRs. Measure the resistance across the pair of SCRs (the load must be disconnected), the resistance should be infinite in both directions. If a short is indicated, replace the defective SCR or return the unit to the factory.
3. Defective Firing Circuit	Disconnect power and unplug the Firing Circuit. Order a replacement or return the Power Controller to the factory.

NOTE: Virtually any failures of SCRs or Fuses on Zero-Fired equipment can be attributed to short circuits in the load or loose power connections that cause arcing or sparking.

WARNING

Always disconnect the power source prior to attempting to service the equipment.

Section 5 - SERVICE AND SPARE PARTS

5-1 CUSTOMER SERVICE

If you have operational problems which cannot be resolved using this manual, please contact the Service Department at AMETEK HDR. Our normal work hours are 8 a.m. to 5:00 p.m., U.S.A. EASTERN TIME ZONE, Monday through Friday.

TELEPHONE: 1-888-PWR-CNTL (797-2685) OR 614-308-5500.

Our answering machine at 614-308-5500 will answer after hours and we will return your call the next working day.

FAX: 614-308-5506. 24 hours per day automatic answering.

5-2 SPARE PARTS

Inside Sales should be contacted for any spare parts orders whether routine or emergency during normal working hours. All after hours requirements should be called in on our 614-308-5500 answering machine. Please have as much information available as possible pertaining to the model number, serial number, order number and parts required. A purchase order number should be available.

5-3 WARRANTY

AMETEK HDR warrants that the equipment delivered will be free from defects in workmanship and material for a period of five years from the date of shipment. AMETEK HDR will repair or replace, at AMETEK HDR's option, any part found defective during proper and normal use, provided that written notice of the nature of the defect is received by AMETEK HDR within the five year warranty period and that the customer returns the part to AMETEK HDR freight paid both ways. This warranty is not transferable by the initial end user.

AMETEK HDR MAKES NO OTHER WARRANTIES, EXPRESSED OR IMPLIED (INCLUDING, WITHOUT LIMITATION, MERCHANTABILITY, FITNESS FOR PURPOSE, OR AGAINST INFRINGEMENT OF ANY PATENT) EXCEPT AS EXPRESSLY PROVIDED HEREIN.

THE REMEDY OF REPAIR OR REPLACEMENT IS CUSTOMER'S SOLE AND EXCLUSIVE REMEDY AND WILL SATISFY ALL OF AMETEK HDR'S LIABILITIES, WHETHER BASED ON CONTRACT, NEGLIGENCE, TORT, PRODUCT LIABILITY, STRICT LIABILITY, OR OTHERWISE. IN NO EVENT WILL AMETEK HDR BE LIABLE FOR INCIDENT OR CONSEQUENTIAL DAMAGES, NOR IN ANY EVENT SHALL HDR'S LIABILITY EXCEED THE UNIT PRICE OF ANY DEFECTIVE PRODUCT OR PART.

EC DECLARATION OF CONFORMITY

WE: **AMETEK HDR POWER SYSTEMS**
3563 Interchange Road
Columbus, Ohio 43204 - USA

Declare under our sole responsibility that the products listed below and bearing the CE label:

Type: SCR power controllers with the following model designations and current ratings:

ZF1, ZF2, ZF3, PF1, PF3 - 15, 25, 40, 60, 70, 90, 120, 180,
225, 350, 500, 650, 800, 1000 and 1200A.
SHZF1, SHPF1 - 15, 30, 40, 60, 70, 90 and 120A
SHZF2, SHZF3, SHPF3 - 15, 25, 30, 60, 90, 120, 180 and 225A
SCZF1, SCPF1 - 15, 25, 40 and 65A

To which this declaration relates is in conformity with the technical requirements of the following documents:

Title:	Low-voltage switchgear and controlgear	No.	IEC 947-5-1
		Year:	1990-03
	Low Voltage Directive	No.	IEC 73/23/EEC
		Year:	1973-02
	Degrees of protection provided by enclosures (IP Code):	No.	IEC 529-2nd Edition
		Year:	1989-11

(Certain Tests conducted by an NRTL for Group 2 Class A equipment per CISPR 11 - 2nd edition dated 1990-09 with amendments and IEC 947-5-1)

Warning

All phase-fired (PF) controllers will require line filters and possibly shielded cables to meet the LVD requirements.

(Environmental protection classification IP00 - for mounting inside an enclosure)

Note: Characteristics are according to manufactures specifications.

Name: George A. Sites



Title: Vice President

Date: June 26, 1999

Declaration written in accordance with I.S.O. - IEC/22 Guide